



COMMERCIAL HEAVY-DUTY PLASTIC TOILET SEAT

MODEL #

COLOR #

95CT/95SSCT

DESCRIPTION:

Open front less cover, elongated, heavy-duty, injection molded solid plastic toilet seat. Features four molded-in bumpers, non self-sustaining (95CT) or self-sustaining (95SSCT) check hinges with non-corrosive 300 Series stainless steel posts and pintles and STA-TITE® Commercial Fastening System™. This seat complies with American National Standard Z124.5 Toilet (Water Closet) Seats as a class Commercial Heavy Duty.

SPECIFICATIONS:

Size:	Elongated
Material:	Plastic
Style:	Open Front less Cover
Bumpers:	Four
Hinges:	Plastic Non Self-Sustaining (95CT) or Self-Sustaining (95SSCT) with 300 Series Stainless Steel Posts and Pintles
Fastening System:	STA-TITE® Commercial Fastening System™

FEATURES:

- STA-TITE® Commercial Fastening System™
- Non-Corrosive 300 Series Stainless Steel Posts and Pintles

DIMENSIONS:

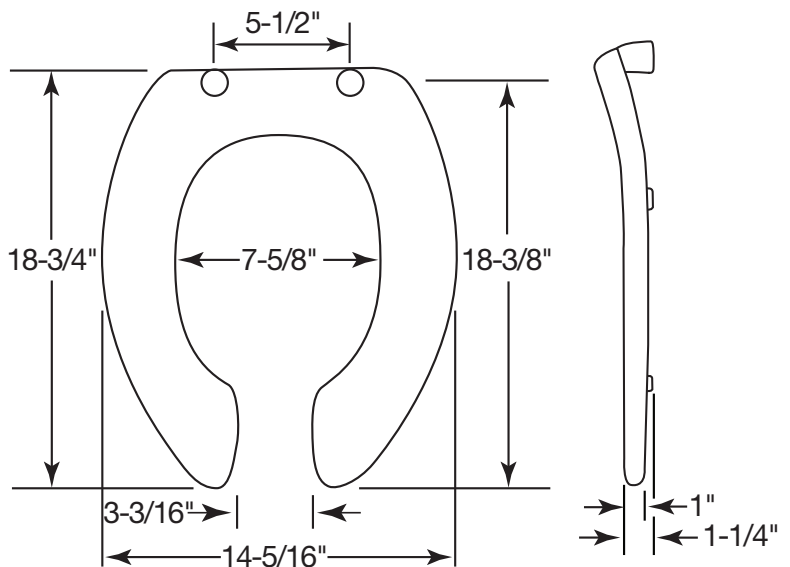

PLASTIC HINGES WITH STAINLESS STEEL POSTS AND PINTLES

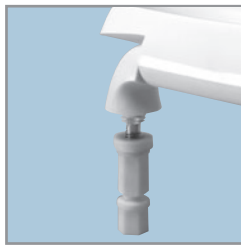

STA-TITE® COMMERCIAL FASTENING SYSTEM™

